



www.gillathletics.com  
800-637-3090

## 504 - STAINLESS STEEL VAULT BOX SPECIFICATIONS

### SPECIFICATIONS

The 504 Stainless Steel Vault Box is fabricated from a corrosion resistant stainless steel alloy. The sides and bottom of the box are cut out and folded from a single sheet. The box backstop is welded to the sides and bottom with a continuous weld along the outside edge. The upper edges along the front, sides, and back are folded over to eliminate any sharp edges. Extra front and rear folds secure the box position when placed in concrete.

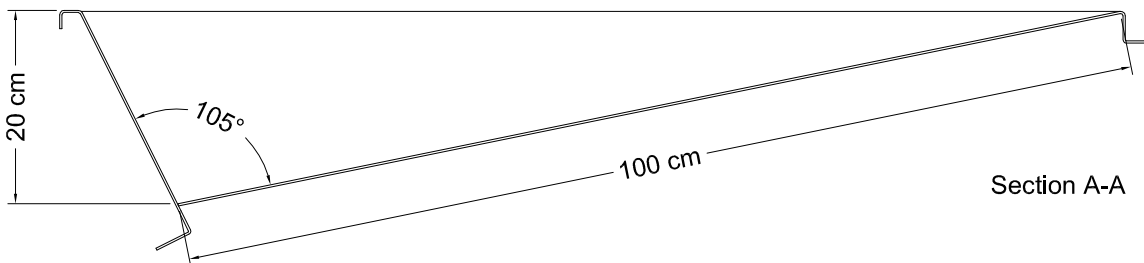
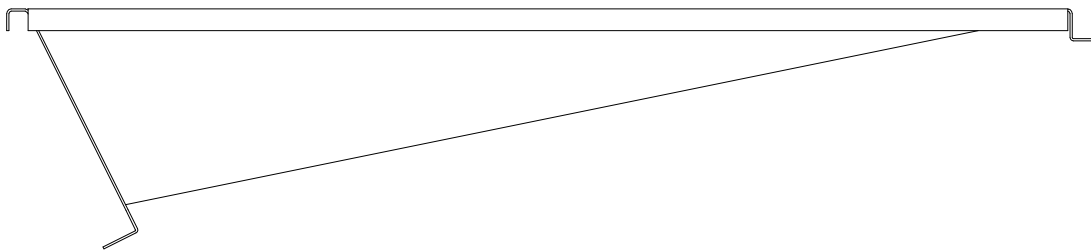
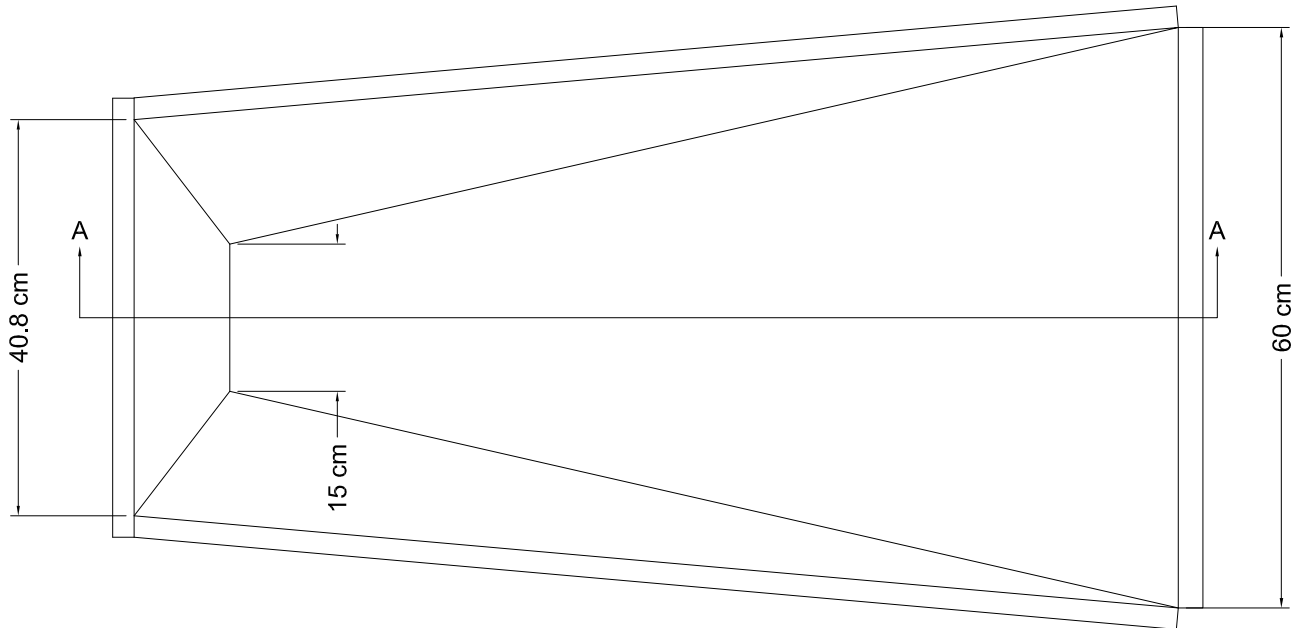



www.gillathletics.com  
800-637-3090

# 500 SERIES VAULT BOXES 500, 502, & 504 INSTALLATION INSTRUCTIONS

## INSTALLATION OF BOX IN NEW OR EXISTING RUNWAY

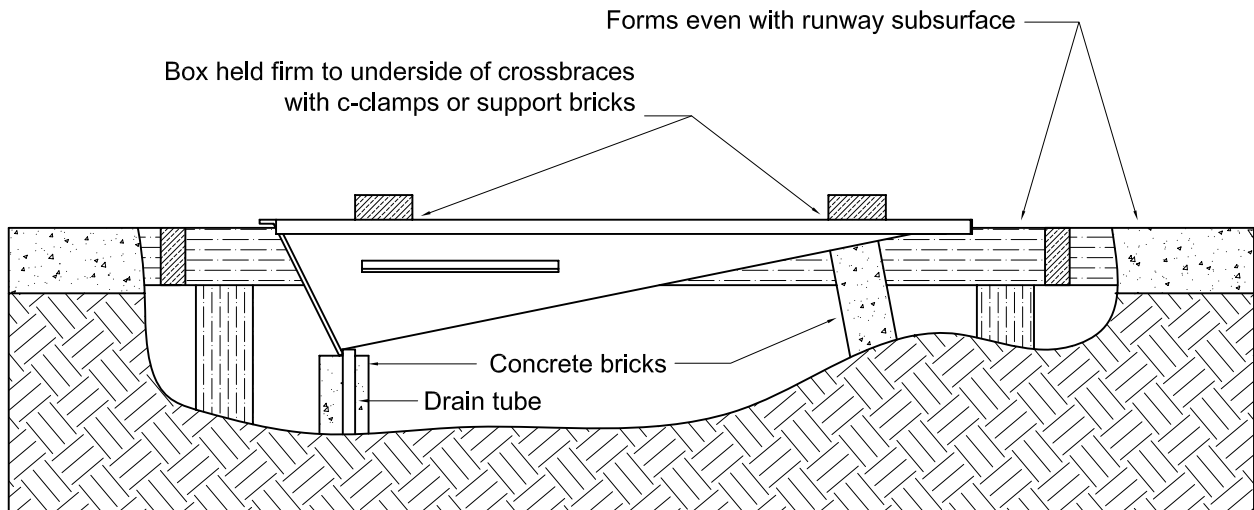
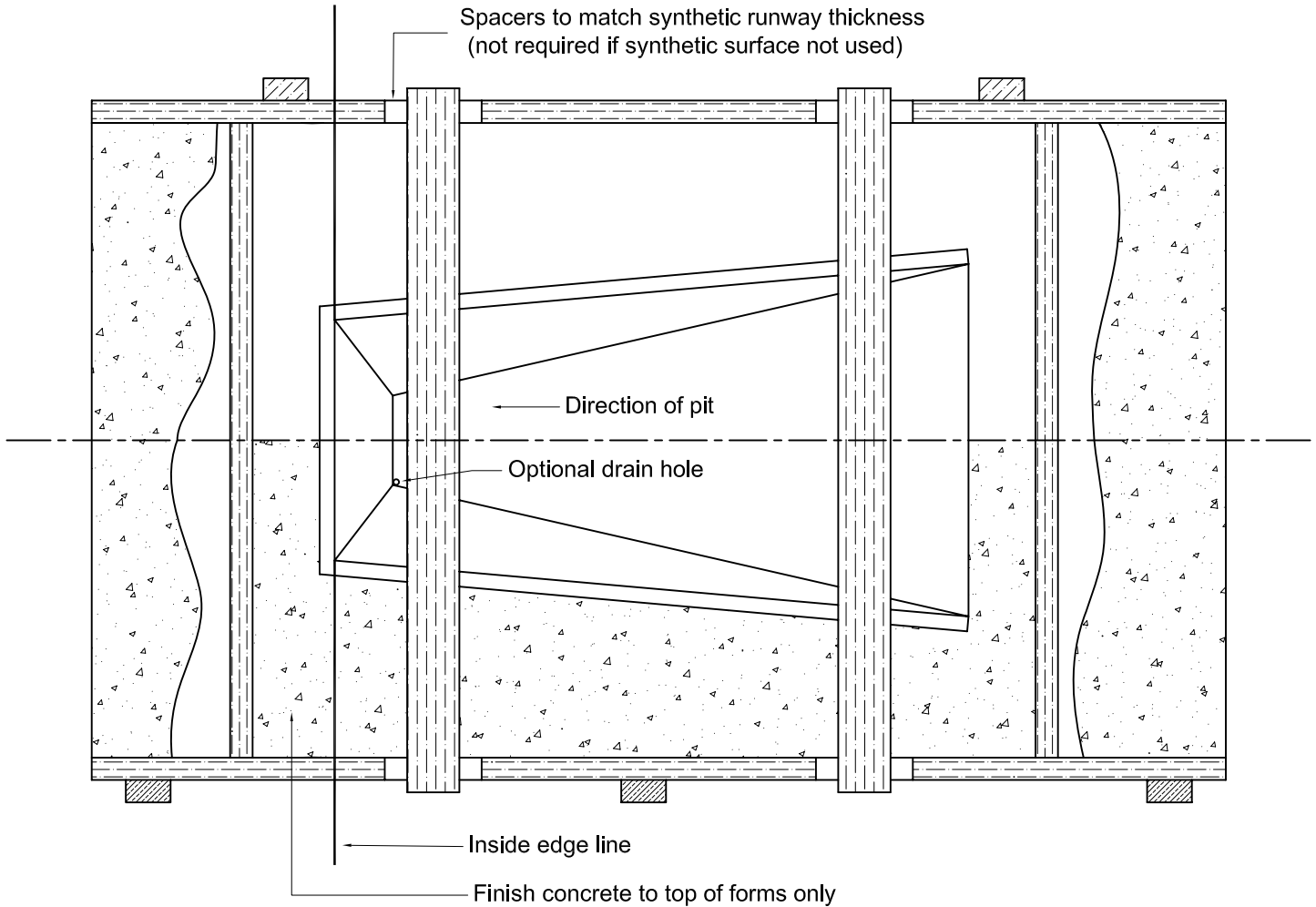

NOTICE: All installations should be conducted by experienced contractors and in accord with all applicable codes, laws and regulations. Suggested instructions herein are illustrative only and should be adapted to suit local requirements. Gill Athletics is not responsible for the manner in which these products are installed.

GILL ATH  
10/24/04

Copyright ©2005 by Gill Athletics. All rights reserved.

500-502-504\_inst1



www.gillathletics.com  
800-637-3090

# 500 SERIES VAULT BOXES 500, 502, & 504 INSTALLATION INSTRUCTIONS

## INSTALLATION OF BOX IN GYM FLOOR

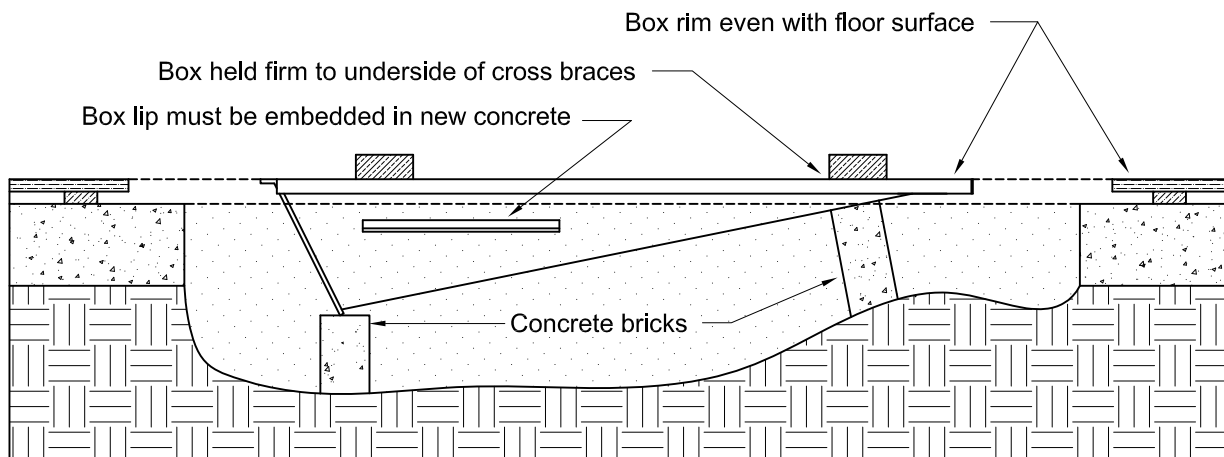
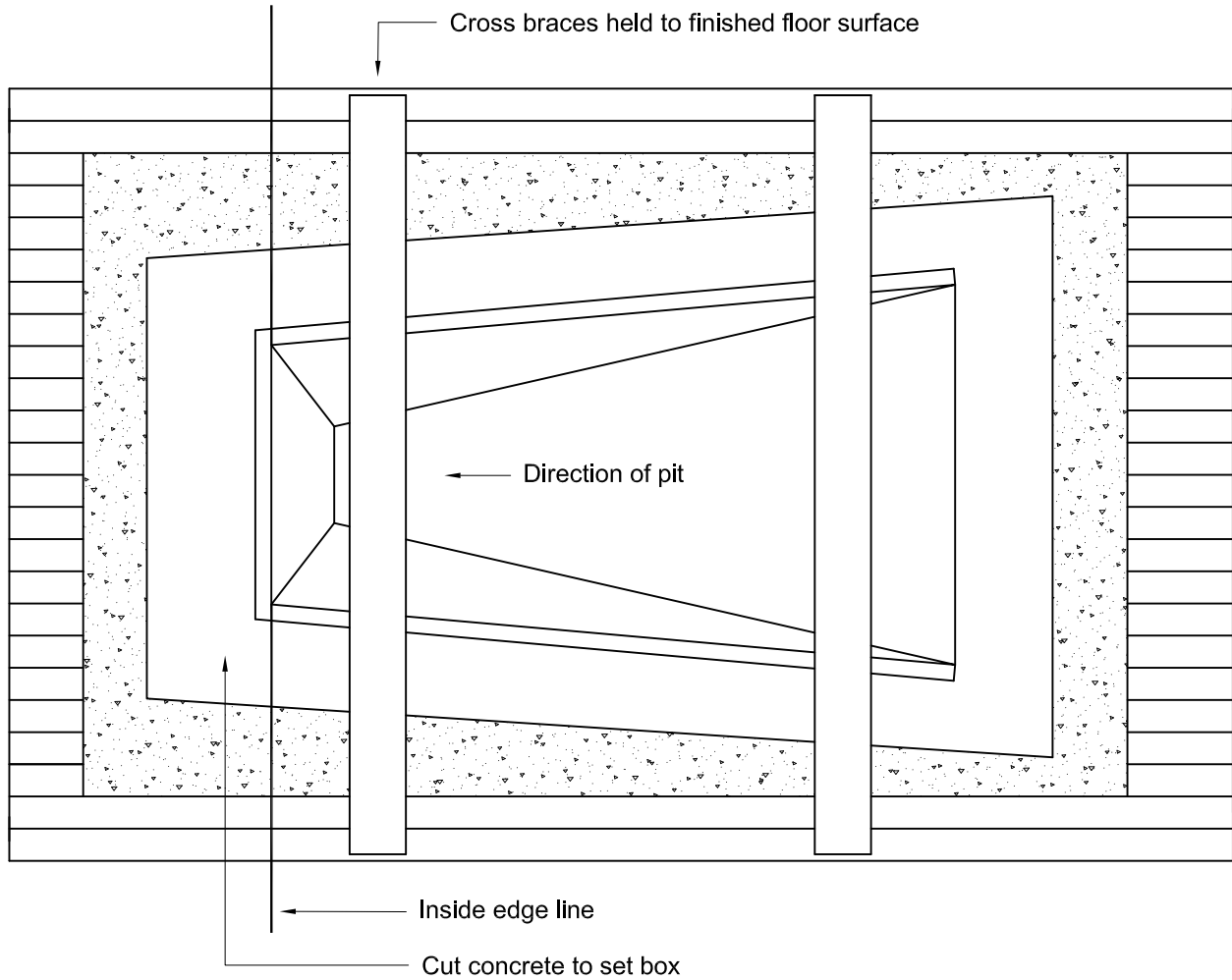

**NOTICE:** All installations should be conducted by experienced contractors and in accord with all applicable codes, laws and regulations. Suggested instructions herein are illustrative only and should be adapted to suit local requirements. Gill Athletics is not responsible for the manner in which these products are installed.

THIS WARNING IS GIVEN IN COMPLIANCE WITH CALIFORNIA'S PROPOSITION 65:

**WARNING**

This product contains chemicals known to the State of California to cause cancer, birth defects or other reproductive harm.

suggestions@gillathletics.com  
Copyright ©2005 by Gill Athletics. All rights reserved.

GILL ATH  
02/27/02  
500-502-504\_inst2