

#7257-01 - FIRST PLACE HIGH SCHOOL ALUMINUM DISCUS CAGE WITH GROUND SLEEVES (6 POSTS)

LAYOUT AND GENERAL INSTALLATION INSTRUCTIONS

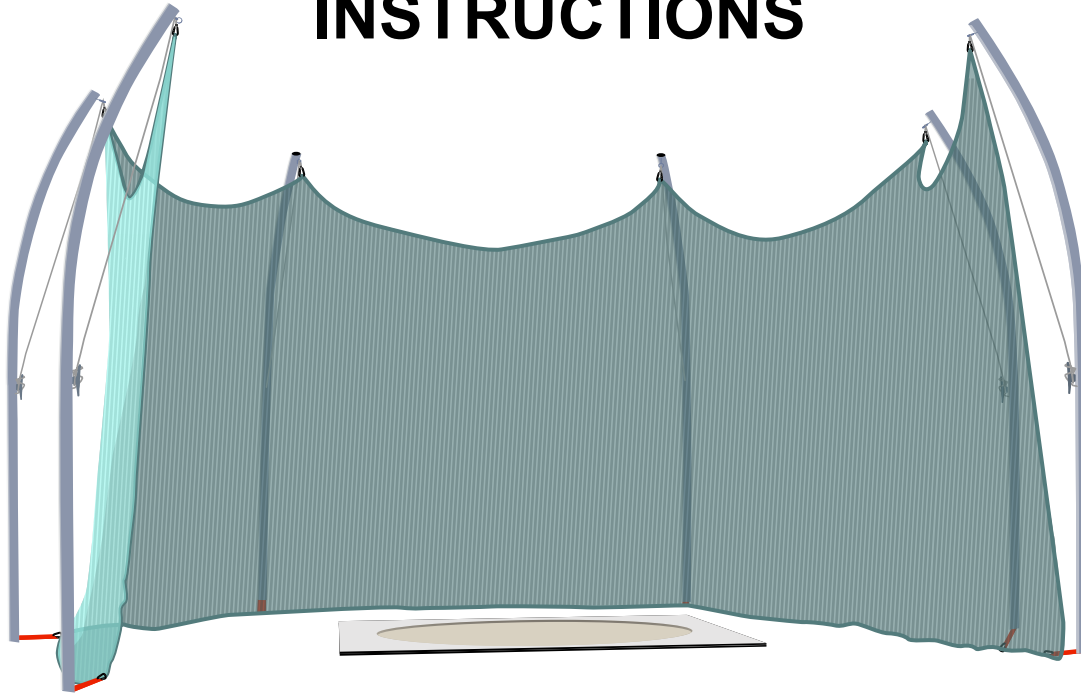

IMPORTANT

Before starting installation of this discus cage, read all information contained on these pages and carefully inspect area both above and below the ground for obstructions such as electrical wires which could cause loss of life if not properly handled.

Installation of this product should be done by an experienced contractor following all applicable codes, laws and regulations. These instructions are meant to be a guide and may need to be adapted to local requirements. M-F Athletic is not responsible for the manner in which this product is installed.

PARTS

Part #	Description	Qty	Part #	Description	Qty
1	Ground Sleeve (28¼" H)	6	6	Warning Sign	3
2	Ground Sleeve Cap	6	7	Alignment Tool	1
3	Cage Net Post (15'6" H)	6	8	Plastic Wire Tie	12
4	Net (58' L x 13' H)	1	9	Tension Arm	6
5	Net Rope (3/8" x 20') w/clip	6	10	Rubber Pad	6

(Part 1) - GROUND SLEEVE INSTALLATION



Everything Track & Field

V.7257-01.2

Diagram-1

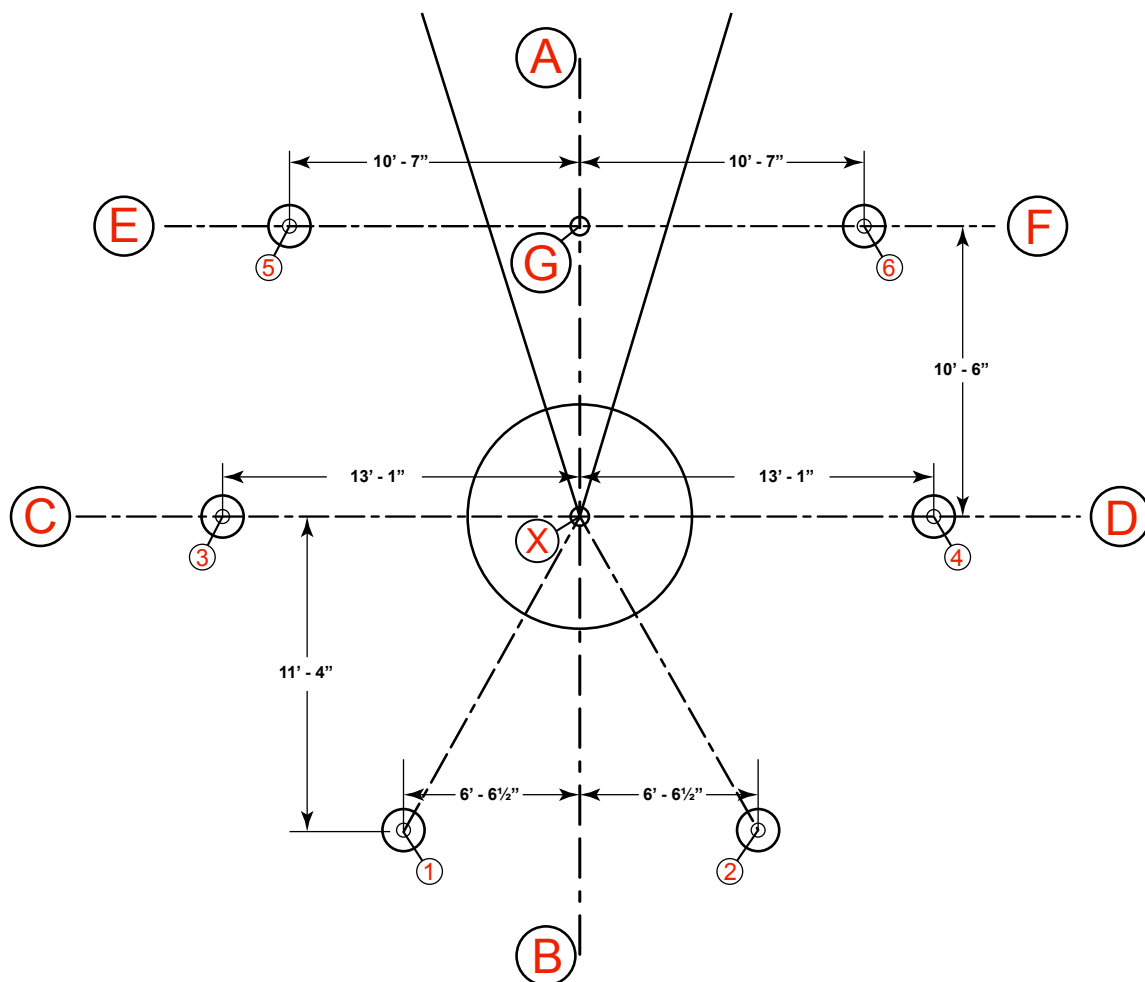

Step 1: Locate the center point of the discus throwing circle (X).

Step 2: Mark the sector center line "AB" by running a string through the center point of the throwing circle "X" as shown above. Extend the string a minimum of 12' on either side of the center point "X" and stake each end to keep in place until measuring is complete.

Step 3: Run a second string line "CD" perpendicular to the sector center line "AB" and through the center point of the throwing circle "X". Extend the string a minimum of 14' on either side of the center point "X" and stake each end to keep in place until measuring is complete.

Step 4: Using the measurements shown above in diagram (Diagram-1), mark points 1, 2, 3 & 4.

Step 5: Run a third string line "EF" at a distance 10'6" forward (towards point "A") of line "CD" and perpendicular to line "AB" intersecting at point "G". This string should extend a minimum of 11' on either side of point "G".

Step 6: Using the measurements shown in the above diagram (Diagram-1), mark points 5 & 6.

NOTE: Points "1" thru "6" are the locations of the center of the ground sleeves that will now be installed.

Step 7: Once all measurements are complete and points 1 - 6 are well marked, remove string used in the previous steps.

(Part 1) - GROUND SLEEVE INSTALLATION CONTINUED



Everything Track & Field

V.7257-01.2

Part #1

Ground Sleeve



Is used as the base for the net posts to keep net posts in proper positions.

Alignment Bolt

Part #2

Ground Sleeve Cap



Part #7

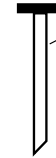

Alignment Tool

Is used as a sight locator made to fit into ground sleeve.

Diagram-2

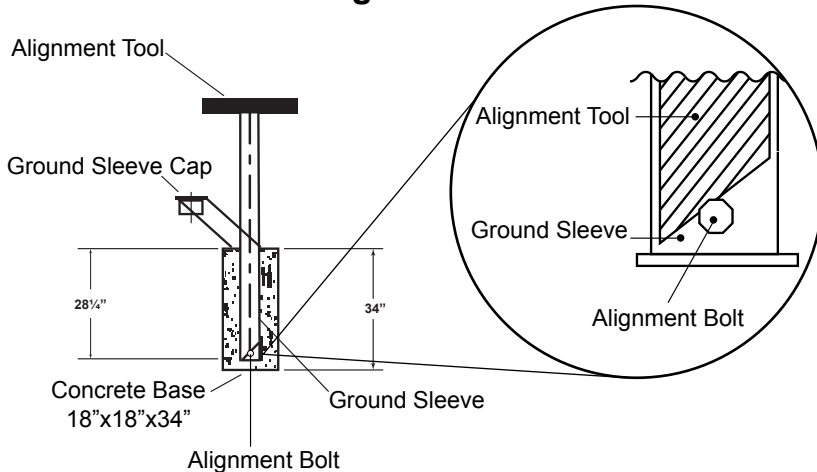
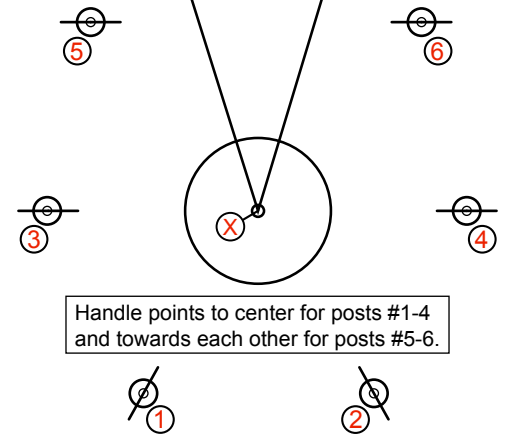

Diagram-3

Top view of Alignment Tool when in proper position.



Handle points to center for posts #1-4 and towards each other for posts #5-6.

Step 8: At each of the six ground sleeve locations "1" thru "6", drill or dig an 18" diameter hole a minimum of 34" deep. Note: Soil conditions vary greatly so your site may require that a larger diameter cement area be poured. Consult local building codes for concrete depth and drainage requirements.

Step 9: Mark the center point of each of the six holes using crossed strings. Place string approximately 2" above ground level.

Step 10: Lay out all six ground sleeves (Part #1) and note the end of each ground sleeve which has the alignment bolt passing through the sleeve.

Step 11: Place one ground sleeve (Part #1) into each hole location making sure that the end with the alignment bolt goes into the hole first. (Bolt end closest to the bottom of the hole) Make sure that the top of each sleeve sits at ground level. It is also important that the sleeve is centered, level and plumb.

Step 12: Place the alignment device (Part #7) into each ground sleeve one by one so that the bottom angled end of the alignment tool slides past the alignment bolt and locks into place. (Diagram-2)

NOTE: Each sleeve must be positioned so that the net posts will face the proper direction as shown in Diagram-3.

Step 13: Rotate alignment tool so that its "T" shaped handle points directly at the center of the throwing circle (X) for locations 1 - 4 and towards point (G) for positions 5 & 6 as shown in Diagram-3.

Step 14: Once properly aligned, secure each sleeve with wire and short pieces of rebar before cementing. This will help to keep the sleeve in proper position during the cementing process.

IMPORTANT: BEFORE CEMENTING CHECK THAT EACH SLEEVE IS ALIGNED CORRECTLY PER Diagram-3 AS INCORRECT ALIGNMENT WILL RESULT IN AN UNUSABLE CAGE.

Step 15: Carefully pour cement around each ground sleeve making sure not to get any concrete inside the sleeve. As the concrete cures, repeatedly check the sleeves to make sure that they are centered, level and plumb, in proper alignment and that the top of the sleeve is sitting at ground level and not higher.

Step 16: Once concrete has hardened, apply one ground sleeve cap (Part #2) to the top of each ground sleeve. Make sure to allow concrete to fully cure before proceeding to the next step.

(Part 2) - CAGE POST AND NET INSTALLATION



Everything Track & Field

V.7257-01.2

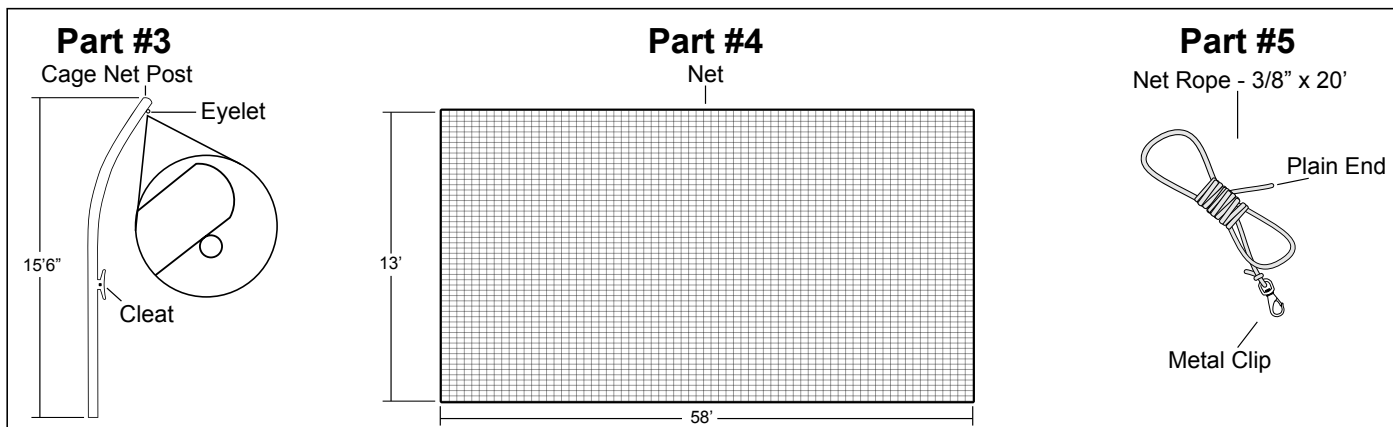

Diagram-4

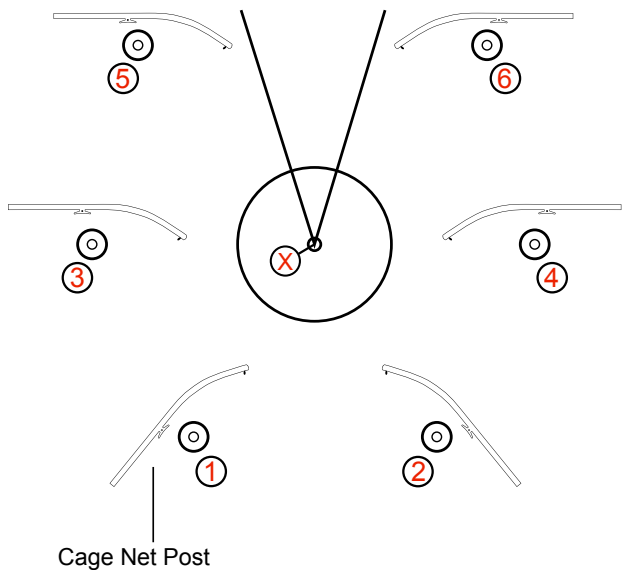
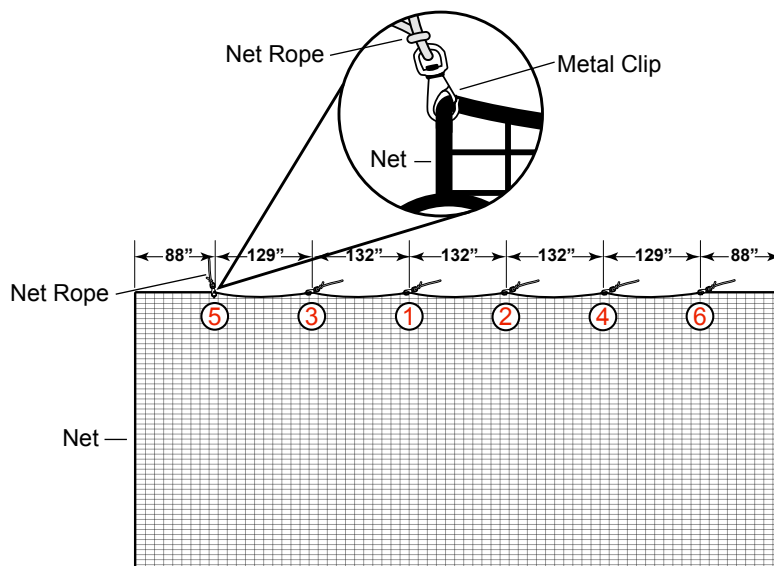

Diagram-5



Step 1: Lay one cage post (Part #3) on the ground next to each ground sleeve with top portion of post pointing towards the inside of the throwing area. (Diagram-4)

Step 2: Unroll net (Part #4) and layout across an open area of ground.

Step 3: The net comes packed tightly and requires stretching to come to full size. Using a partner, grab an edge of the net on opposite sides from each other and stretch the net so that it is no longer bunched up. Walk around net stretching each portion until all sides have been fully stretched.

Step 4: Using the tape measure, mark each of the six "hook" locations on the net as pictured above in Diagram-5. These points will be where the net ropes will be attached in a future step and are important so to maintain proper spacing of the net once installed. **Note: The net must be stretched tightly when measuring to ensure a proper fit.**

(Part 2) - CAGE POST AND NET INSTALLATION CONTINUED



Everything Track & Field

V.7257-01.2

Diagram-6

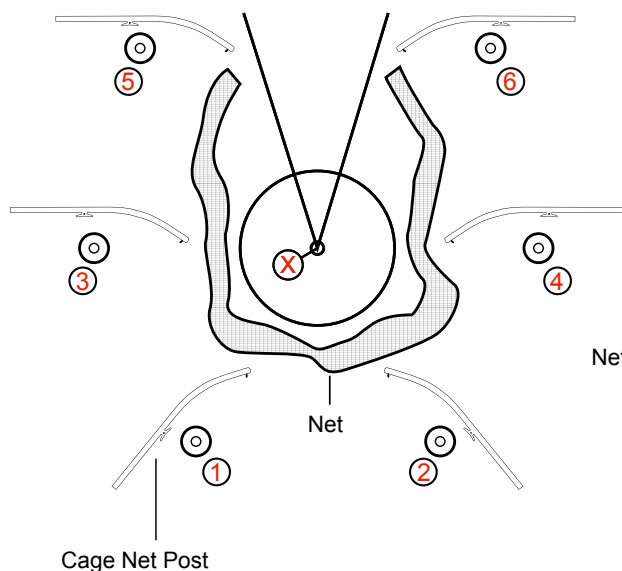

Diagram-7

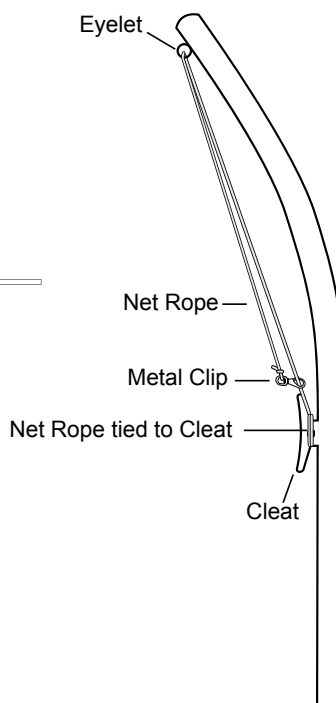
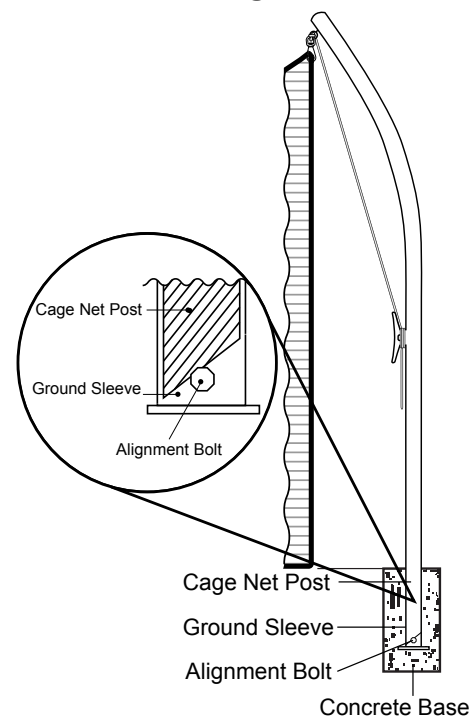

Diagram-8



Step 5: Arrange the net in a loose "U" shape on the ground around the throwing circle and in front of the ground sleeves with previously marked "hook" positions closest to the ground sleeves. (Diagram-6)

Step 6: Locate the plain end (not the end with metal clip) of one net rope and run this end through the eyelet at the top of one cage post and tie off to the cleat located mid-way up the cage net post. Be sure to use only an amount of rope needed to tie the rope successfully to the cleat as slack is needed at this point.

Step 7: Grasp the metal clip at the opposite end of the rope and hook it back to the rope just above the cleat as shown above in Diagram-7. This will keep the rope from swinging during post installation.

Step 8: Repeat for remaining five posts.

NOTE: At this point the cage posts and net should still be laying on the ground with the net positioned in the area between the throwing circle and ground sleeves.

Step 9: Remove ground sleeve caps (Part #2) from each ground sleeve.

Step 10: One by one, lift each cage post to a vertical position and slide into ground sleeves. **NOTE: The curved top of the post should point towards the inside of cage with posts 1 - 4 pointing at the center of the circle and posts 5 & 6 pointing towards each other. Be sure that the angled bottom portion of each cage net post slides past the alignment bolt located within the ground sleeve and locks into place. (Diagram-8) This will ensure that the cage net post cannot swivel out of position.**

Step 11: Once all cage net posts have been inserted into ground sleeves, go to post 6, unhook the metal clip from the cleat, and clip it to the thick edge border of the net where previously marked. Lifting of the net by hand may be required to complete this step.

Step 12: Repeat step 11 for the remaining posts in the following order. (4, 2, 1, 3, 5)

Step 13: Return to post 6, untie the rope from the cleat and pull the rope downward towards the ground raising the net until the metal clip hits the metal loop at the top of the post. Maintain tension on the rope so that the net remains in the full upright position and tie off the rope to the cleat located on the post. (Diagram-8)

Step 14: Repeat step 13 for the remaining posts in the following order. (4, 2, 1, 3, 5)

NOTE: The top of the net should be snug to the top of each post top and net bottom must also hang loosely on the ground. There will be a natural sagging of the net between posts. The extra net length at each front post should be allowed to hang freely or can be wrapped around the front posts and hooked onto the cleats.

(Part 2) - CAGE POST AND NET INSTALLATION CONTINUED



Everything Track & Field

V.7257-01.2

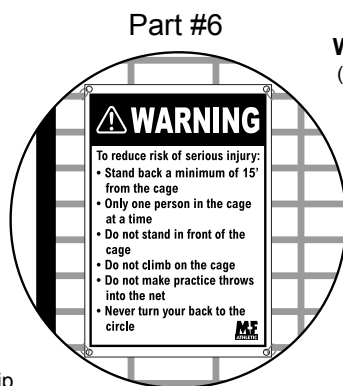
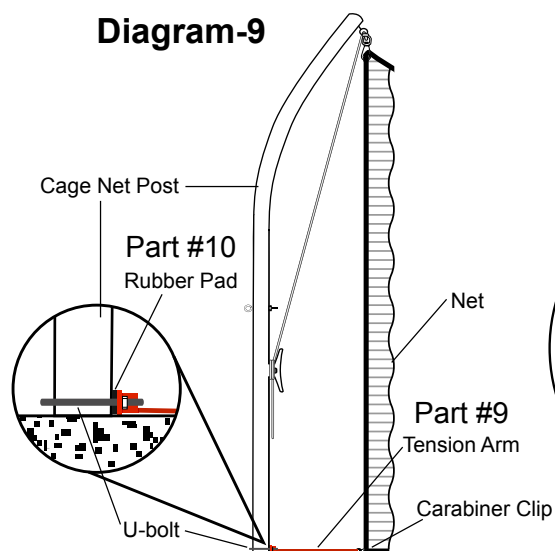
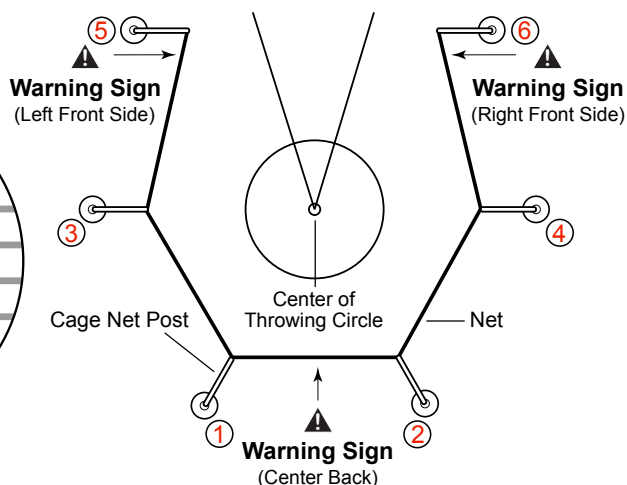

Diagram-10



Step 15: Locate the six tension Arms (Part #9) and lay one at the bottom of each cage post.

Step 16: Separate the U-bolt from each tension arm by first removing the nuts and then place one U-bolt around the bottom of each of the six upright cage posts with the open end of each U-bolt pointing towards the inside of the cage.

Step 17: At each of the six cage posts, place a rubber pad (Part #10) between the cage post and the tension arm while loosely re-attaching the orange tension arm to the U-bolt with the nuts left hand tight at this point. (Diagram-9)

Step 18: For posts 1 - 4, rotate the tension arms so that they are pointing to the center of the throwing circle (Diagram-10) and then tighten the nuts securely.

Step 19: For posts 5 & 6, rotate the tension arms so that they are pointing towards each other (Diagram-10) and then tighten the nuts securely.

Step 20: Attach each tension arm to the bottom of the net using the provided carabiner clip. (Diagram-9)

Step 21: Locate warning signs (Part #6) and using plastic wire ties (Part #8), attach signs to net at positions shown in Diagram-10. **NOTE: Signs should be placed on the outside of the net with the top of the sign 6' from the ground and facing away (towards spectators) from the cage. To prevent injury, loop each wire tie around only one horizontal line of netting and trim excess material from plastic wire ties after attaching signs to net.**

Step 22: Inspect all components and compare to final layout as shown in Diagram-10 above.

Important Safety and Usage Information:

While netting has open areas and does allow some air to flow through it, the net can be moved by wind and therefore should be removed and stored inside during high wind situations to prevent damage to the net, the cage posts and for the safety of those in the area. Before each use, inspect the net for wear and tear. Do not use cage if net integrity is not 100%.

The life span of the net can be extended by storing the net indoors when cage is not in use as this will prevent pre-mature wear due to the sun's UV rays, high winds and other weather related factors.

During severe weather situations, and especially electrical storms, the area in and around the cage must be vacant.

This product meets & exceeds all NFHS rules and specifications.

For technical help, call M-F Athletic at 800-556-7464

©Copyright 2014, MFAC, LLC