



www.gillathletics.com  
800-637-3090

## 80402 - PRO-DOWN DISCUS CAGE W/PLATES SPECIFICATIONS

### SPECIFICATIONS

The 80402 High School Pro-Down Discus Cage with Surface Plates consists of six galvanized steel upright poles and surface plates, five galvanized steel top rungs to eliminate net sag, and a weather treated nylon net. The poles are 12 gauge,  $2\frac{3}{8}$ " O.D. steel tube swaged at the top to receive the top rungs. Each pole stands on an 18" square steel surface plate. Each surface plate is anchored with four 10" ground spikes. The upright pole is held in place by an 18" tall internal tube welded to the plate as well as a 1" diameter ground support pole driven a foot into the ground through a hole in the plate. A stainless steel ring clamp secures the upright pole to the support pole. The top rungs are formed from 1" O.D. 16 gage steel tube and form a solid frame to support the net. The 12' x 63' net is supported by 32 net hooks permanently attached to the top of the net. The nylon net has a breaking strength of 180 lbs and has been weather treated for longer life.

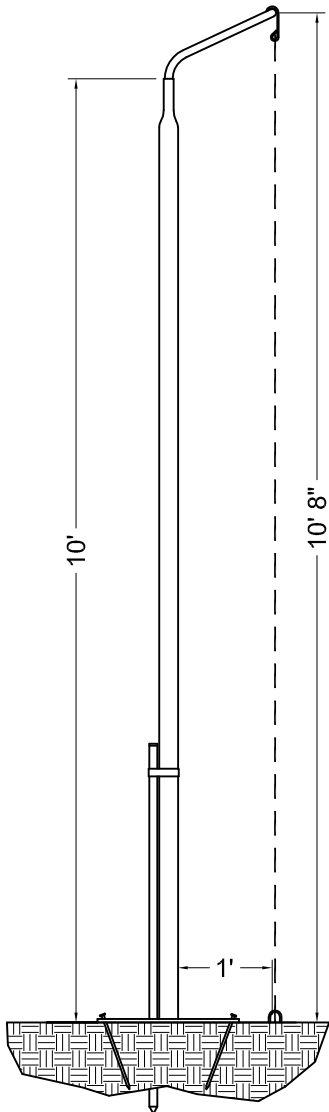

Upright Pole Side View

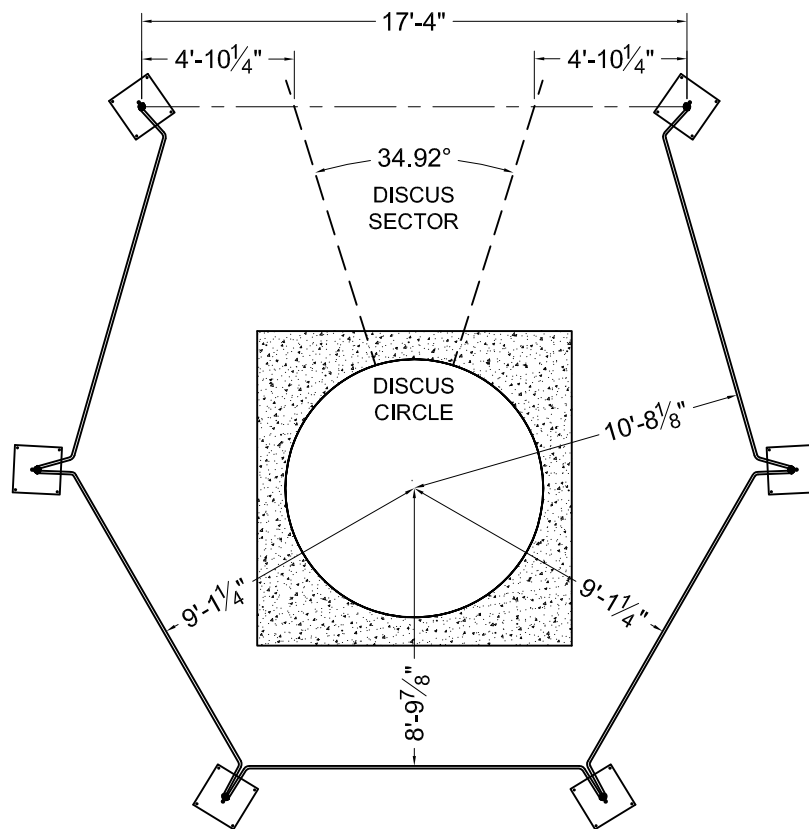

DIAGRAM "A" - Cage Layout

NOTICE: All installations should be conducted by experienced contractors and in accord with all applicable codes, laws and regulations. Suggested instructions herein are illustrative only and should be adapted to suit local requirements. Gill Athletics is not responsible for the manner in which these products are installed.



www.gillathletics.com  
800-637-3090

# 80402 - PRO-DOWN DISCUS CAGE BASE PLATE ASSEMBLY

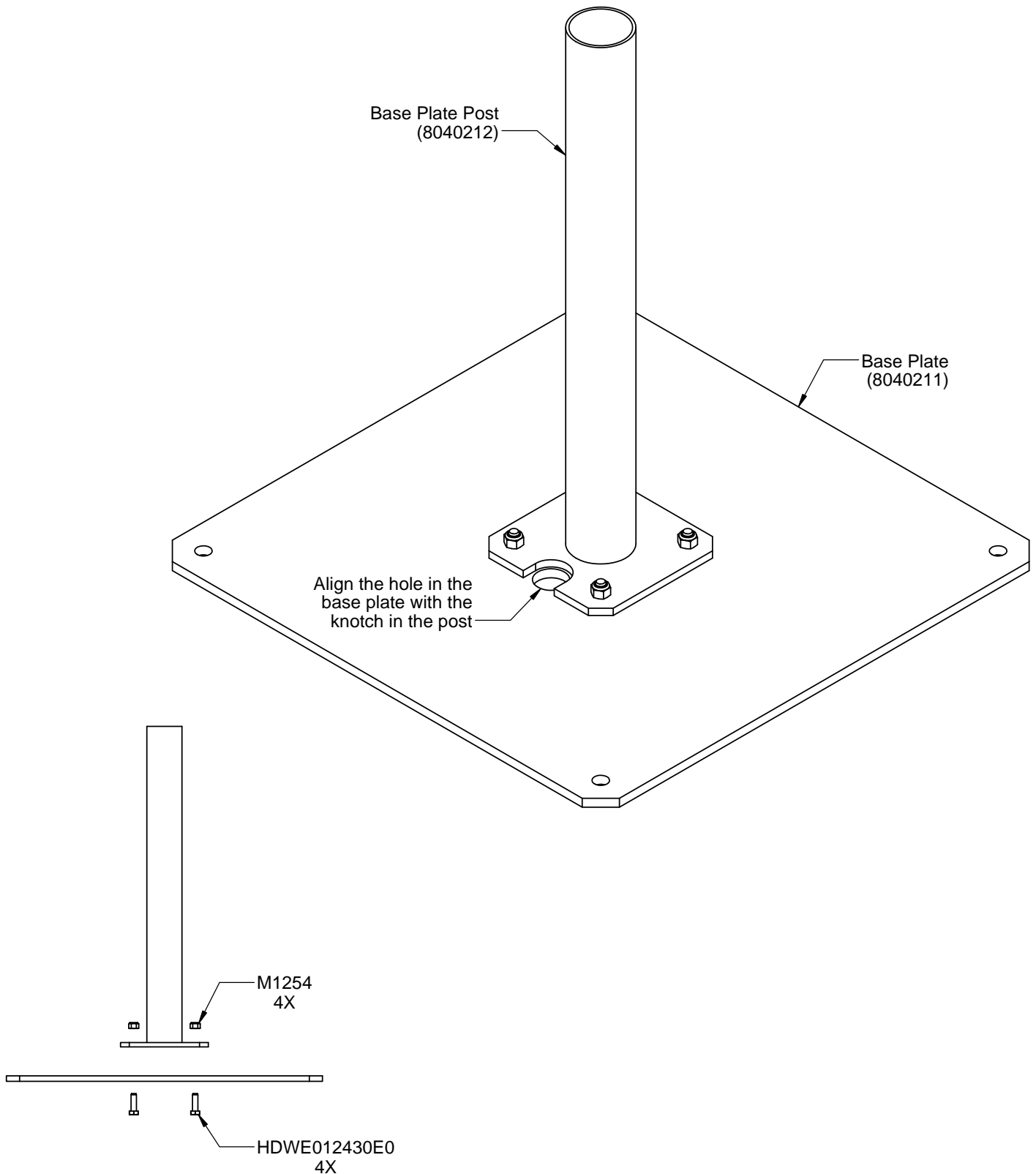



www.gillathletics.com  
800-637-3090

## 80402 - PRO-DOWN DISCUS CAGE W/PLATES INSTALLATION

### INSTRUCTIONS FOR POSITIONING SURFACE PLATES

1. Measure straight back along the sector center line 9'-9 $\frac{3}{4}$ " from the circle center and mark. Measure out 6' perpendicular to the sector center line from this mark in both directions for the center point of the back two Surface Plates. Mark and cross check these two points. They should be 11' 6" from the circle center (refer to Diagram B).
2. Mark the center point for the middle two Surface Plates. These two points are 12' from the rear plate centers and the circle center (refer to Diagram B).
3. Mark the center point for the front two Surface Plates. These two points are 12' from the middle plate centers and 14'-11" from the circle center (refer to Diagram B).
4. Position Surface Plates over each center point as shown in Diagram B. The 1" hole near the center of each plate is for the Ground Support Pole. Position the plates so these holes face away from the circle center.
5. Secure each Surface Plate to the ground with four Ground Spikes inserted through the 1/2" holes at the plate corners. When driving the spikes into the ground, angle each spike in toward the center. This will lock the Surface Plate in position and resist pull out when the cage is in use.
6. Depending on the accuracy of the initial placement of the Surface Plates, it may be necessary to slightly reposition a plate when installing the Upright Poles and Top Rungs.

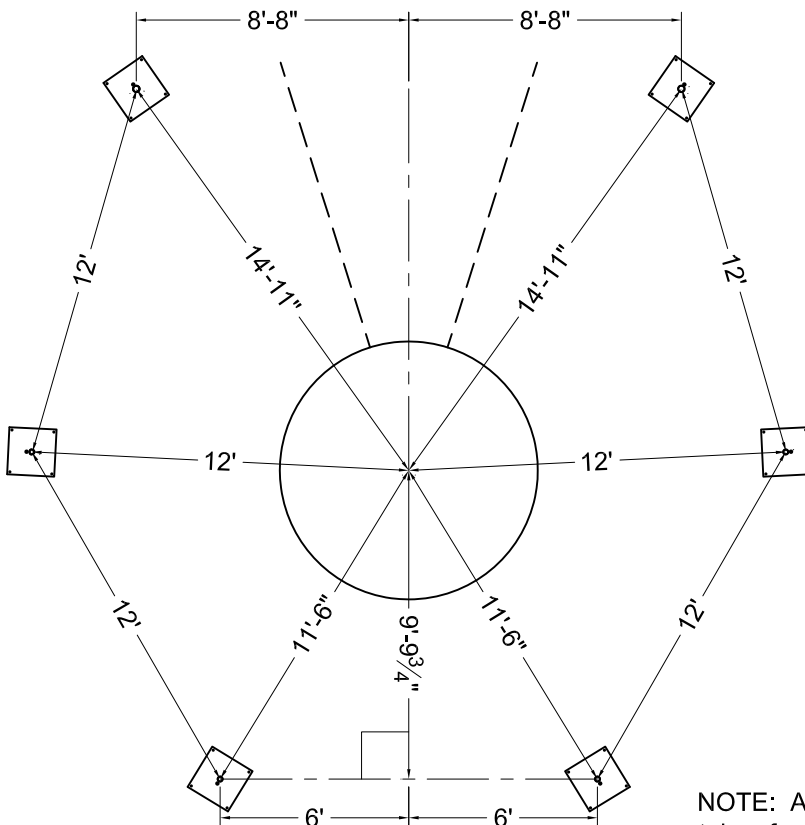
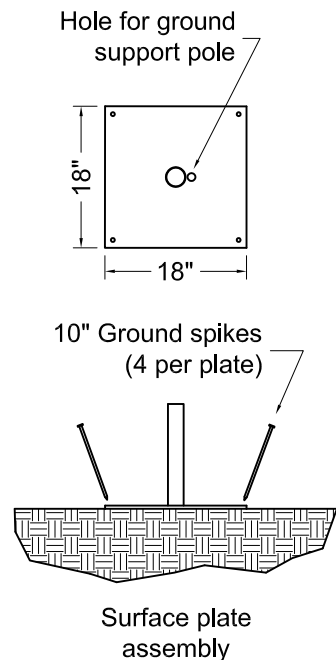

DIAGRAM "B" - Surface Plate Placement



NOTE: All measurements are taken from Surface Plate centers.



www.gillathletics.com  
800-637-3090

# 80402 - PRO-DOWN DISCUS CAGE W/PLATES INSTALLATION

## FRAME ASSEMBLY INSTRUCTIONS

1. Place one Upright Pole with a 4" Ring Clamp over the upright tube on each of the Surface Plates. Starting at the back of the cage, install a Top Rung into the sockets at the top of the pole. The Top Rungs slope inward toward the center of the circle. It will be easier if two people with ladders install each end of the Top Rungs at the same time (see Diagram C1).

2. Install the remaining Top Rungs working toward the front of the cage. It may be necessary to rotate the position of the Upright Pole sockets to ease installation.

3. At each Upright Pole drive a Ground Support Pole 12" into the ground through the 1" hole in the plate. As these support poles help secure the Upright Poles vertical, they must be driven in vertical. Using the 4" Ring Clamp, secure the Upright Pole to the Ground Support Pole (see Diagram C2).

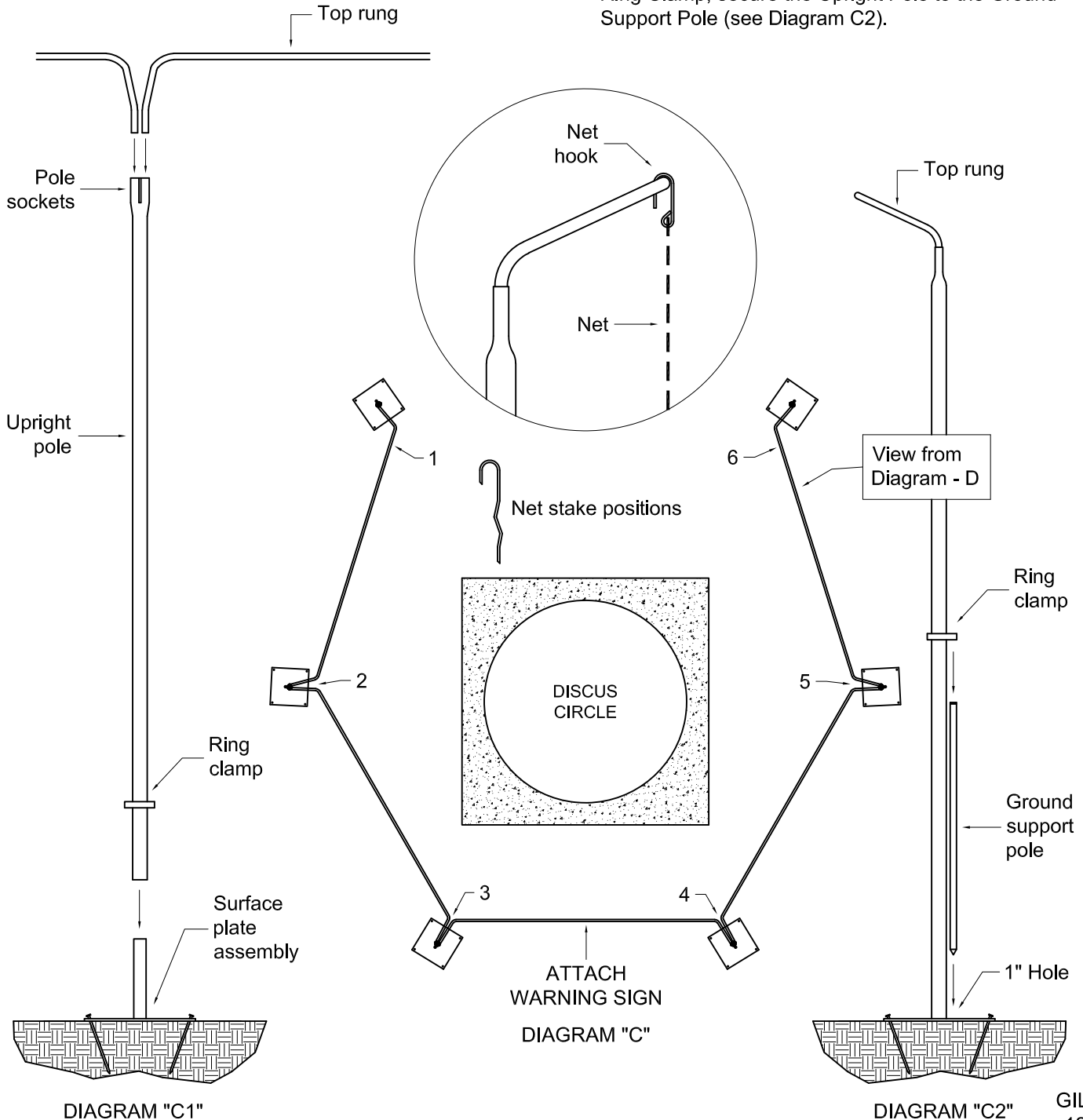

DIAGRAM "C1"

DIAGRAM "C2"

GILL ATH  
12-15-17  
80402-4



www.gillathletics.com  
800-637-3090

## 80402 - PRO-DOWN DISCUS CAGE W/PLATES INSTALLATION

### NET HANGING INSTRUCTIONS

1. Lay the Net out inside the cage with Net Hooks facing the Top Rungs. Using a ladder, place the first corner Net Hook in the open end atop the right front Upright Pole. Place the next Net Hook on the Top Rung and continue hanging Net Hooks on the Top Rungs around the cage frame. The last Net Hook is placed in the open end atop the left front Upright Pole.

2. After net has been hung evenly, secure the sides of the Net to the two front Upright Poles with the 15' Ropes. Tie the Rope into the top grommet of the Net and lace the Rope downward, around the pole and tie at the bottom. Secure the base of the Net with the six Net Stakes at the positions shown in Diagram C. Attach Warning sign to the Net at the back of the cage for the spectators to see.

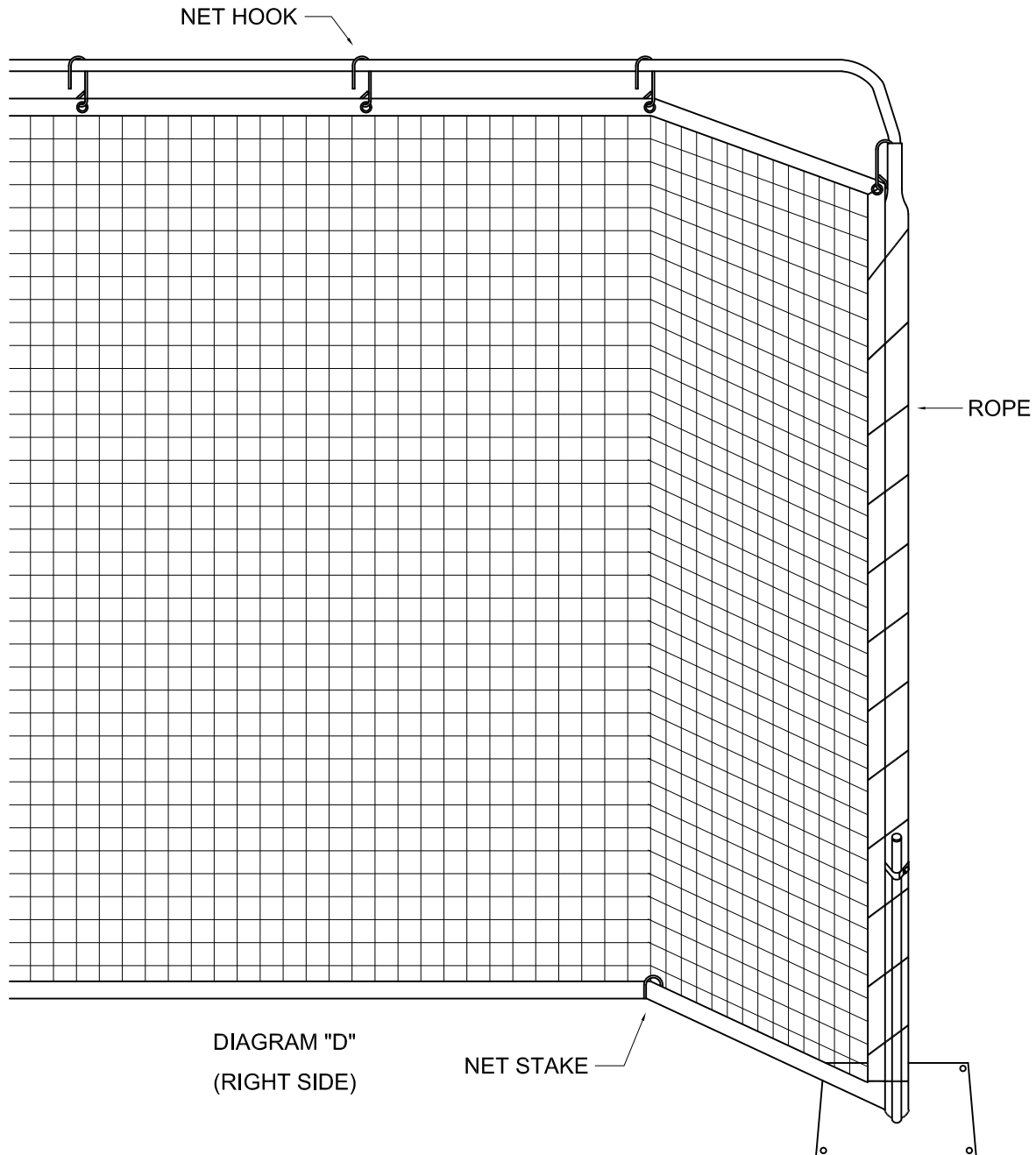

THIS WARNING IS GIVEN IN COMPLIANCE  
WITH CALIFORNIA'S PROPOSITION 65:

**WARNING**

This product contains chemicals known to the  
State of California to cause cancer, birth defects  
or other reproductive harm.

suggestions@gillathletics.com

Copyright ©2012 by Gill Athletics. All rights reserved.

GILL ATH  
04/09/12  
80402-5



www.gillathletics.com  
800-637-3090

# PRO-DOWN DISCUS CAGE SHIPPING LIST

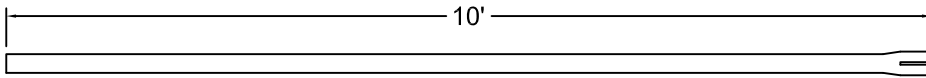

UPRIGHT POLE  
(8040220) x 6

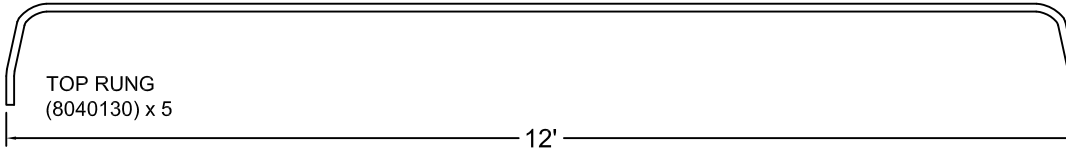

TOP RUNG  
(8040130) x 5

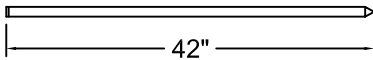

GROUND SUPPORT POLE  
(8040245) x 6

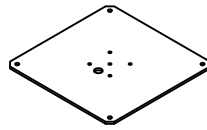

BASE PLATE  
(8040211) x 6



10" GROUND SPIKE  
(M1238) x 24

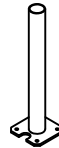

BASE PLATE POST  
(8040212) x 6



4" RING CLAMP  
(M1280) x 6

5/16"-18 NYLOCK NUT  
(M1254) x 24

5/16"-18 x 1" HEX BOLT  
(HDWE012430E0) x 24



NET STAKE  
(ANCR000400E0) x 6

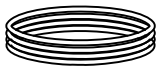

1/4" POLYESTER ROPE  
(M2005) x 50ft



WARNING SIGN  
(M2322) x 3



LOOSE LEAF RING  
(M1250) x 12

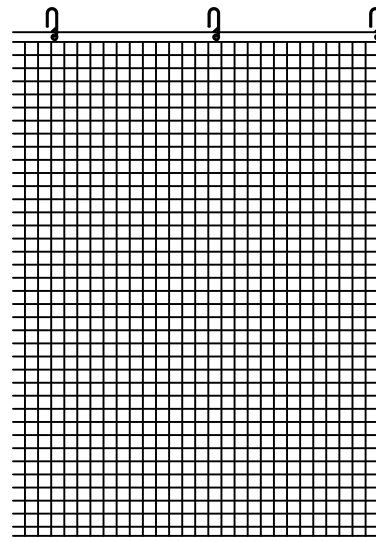

NET W/NET HOOKS  
(80405) x 1